



Power Integrations, Inc.

NASDAQ: POWI

Forward-Looking Statements/Non-GAAP Metrics

These slides may accompany an oral presentation by Power Integrations, Inc., which contains forward-looking statements. Each statement relating to events that will or may occur in the future is a forward-looking statement. The Company's actual results may differ materially from those suggested in the presentation. Information concerning factors that could cause such a difference is contained in the Company's most recent report on Form 10-K.

This presentation may also contain certain non-GAAP financial information. Reconciliations of non-GAAP financial metrics to GAAP results are available in the historical financial tables on the investor page of the Power Integrations website, <http://investors.power.com>.



ICs for Energy Production, Transmission & Consumption



POWER
MANAGEMENT



Technology leader
in ICs for energy-
efficient AC-DC
power supplies



LED
DRIVERS



High-efficiency
driver ICs energizing
the LED lighting
revolution



GATE
DRIVERS



Gate drivers for
renewable energy,
DC transmission,
electric locomotives
and more



MOTOR
DRIVERS



Highly-efficient,
reliable and
integrated motor
drivers



AUTOMOTIVE
SOLUTIONS



Automotive solutions
for efficient, compact
high-voltage power
conversion and
control

What Are Power Converters?

AC-DC

(Power supplies)

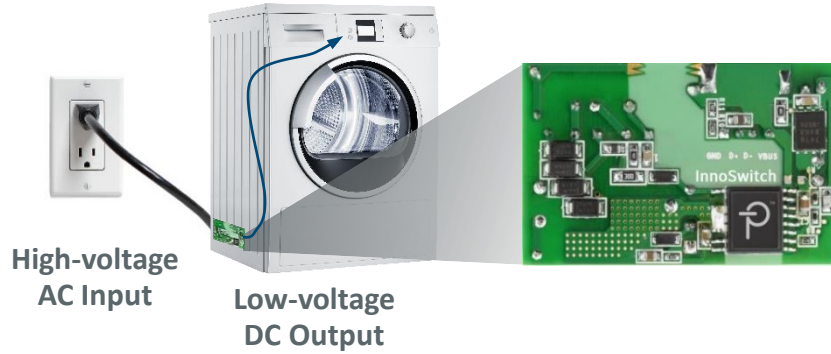

- Converts high-voltage AC to low-voltage DC
- Provides safety isolation
- Efficiency critical

DC-AC

(Inverters)

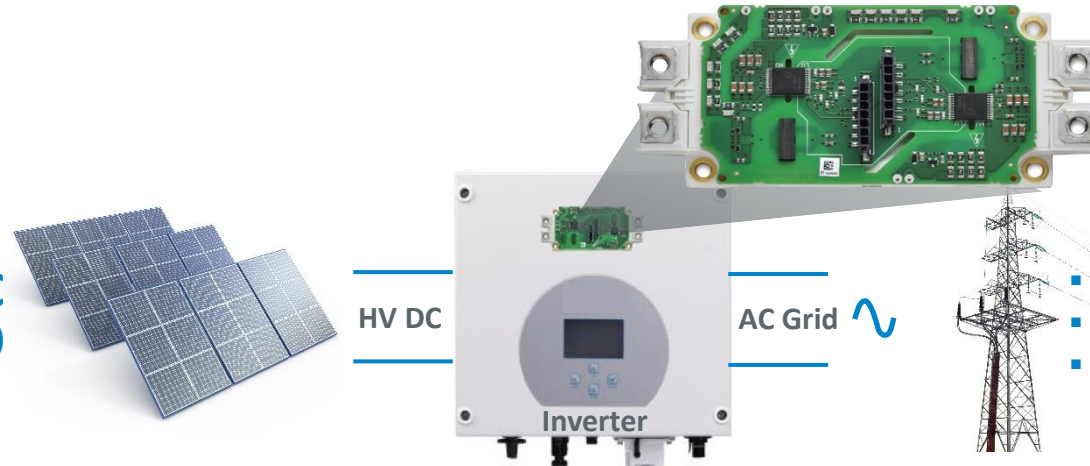

- Converts DC to AC
- Requires safety-isolated gate drivers
- Efficiency critical

Key Takeaways

**High voltage (HV) is a Unique Specialty,
and PI is the Only HV Pure Play**

Our Addressable Market is Expanding
and Diversifying

GaN is the Future of HV Power Conversion,
and PI is the Leader in GaN

High-voltage Semiconductors are Crucial
to a Lower-carbon Future

System-level Solutions for High Voltage Power Conversion

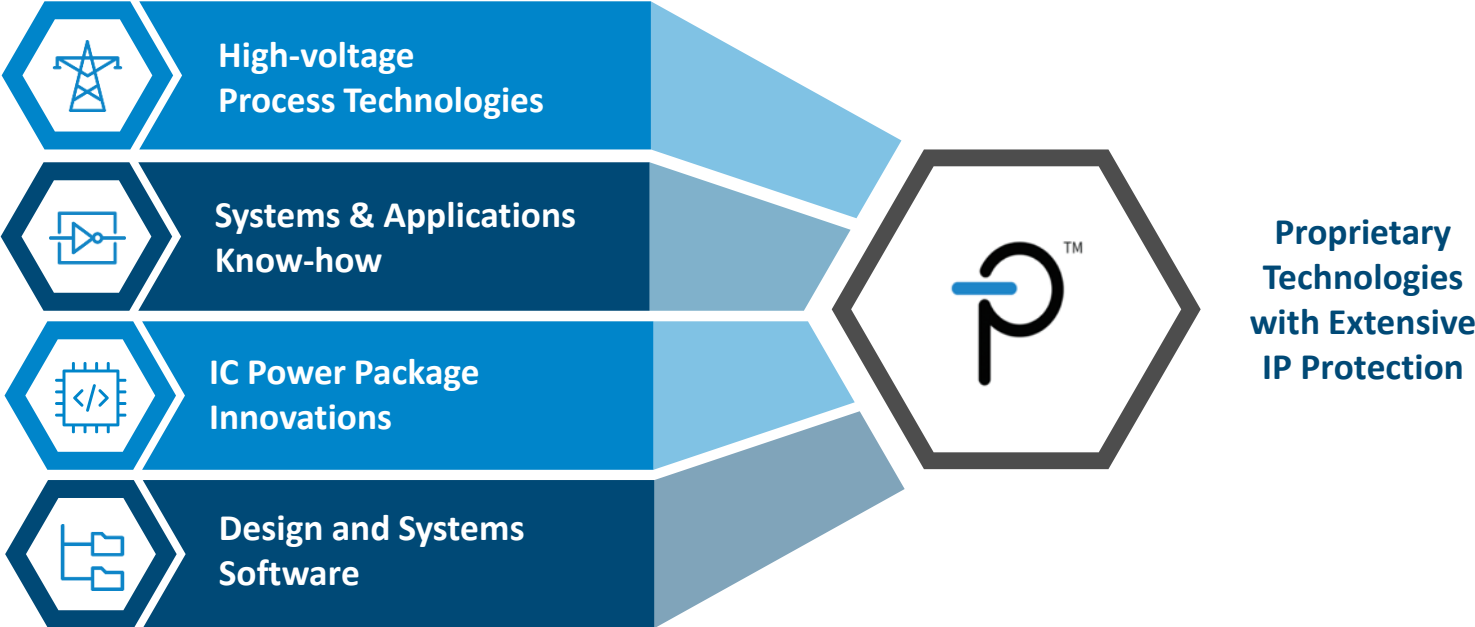

Track Record of Innovation

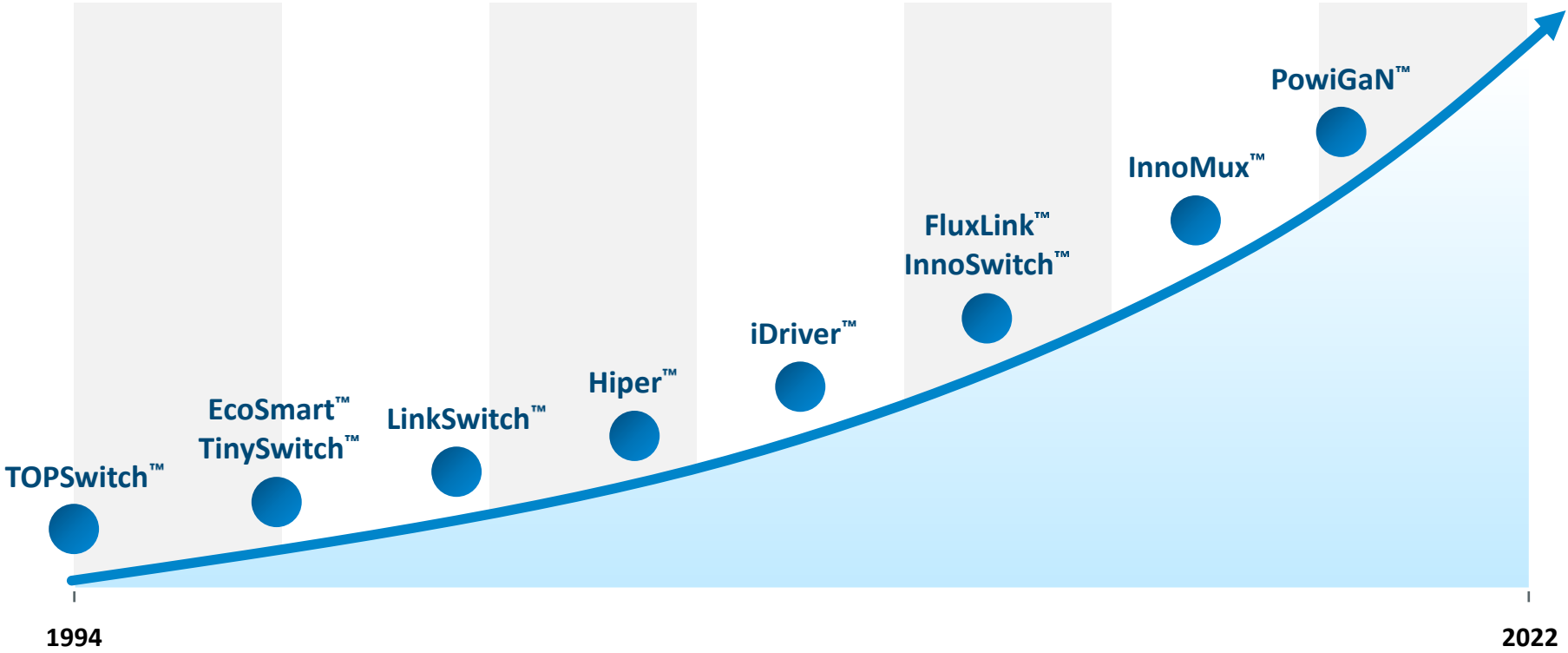

InnoSwitch: A Revolution in HV Power Conversion

Safety-isolated FluxLink Allows Integration of HV and LV sides

- Drastically reducing component count/sourcing and complexity

Choice of Power Switch: Si, GaN, SiC

Proprietary Control Dramatically Increases Energy Efficiency

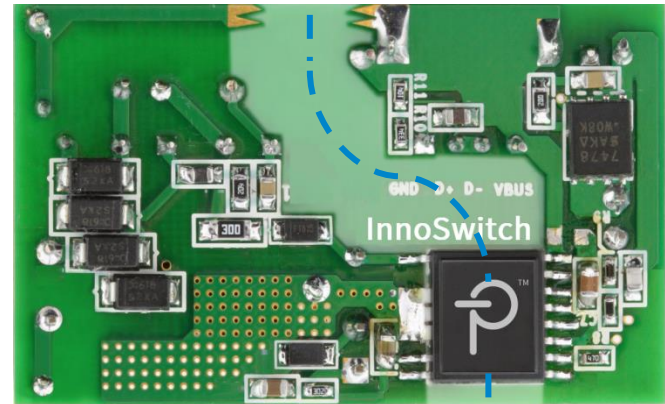
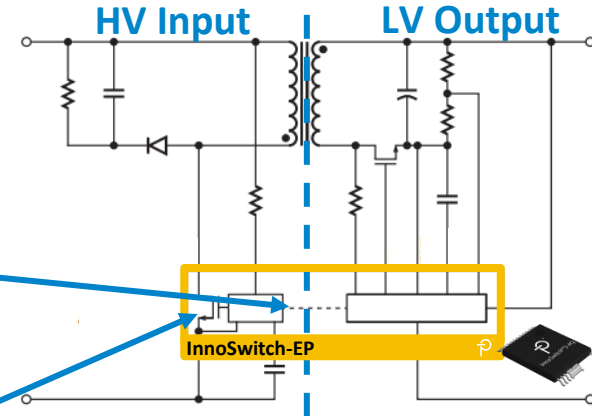

Power Supply Using a PI Competitor

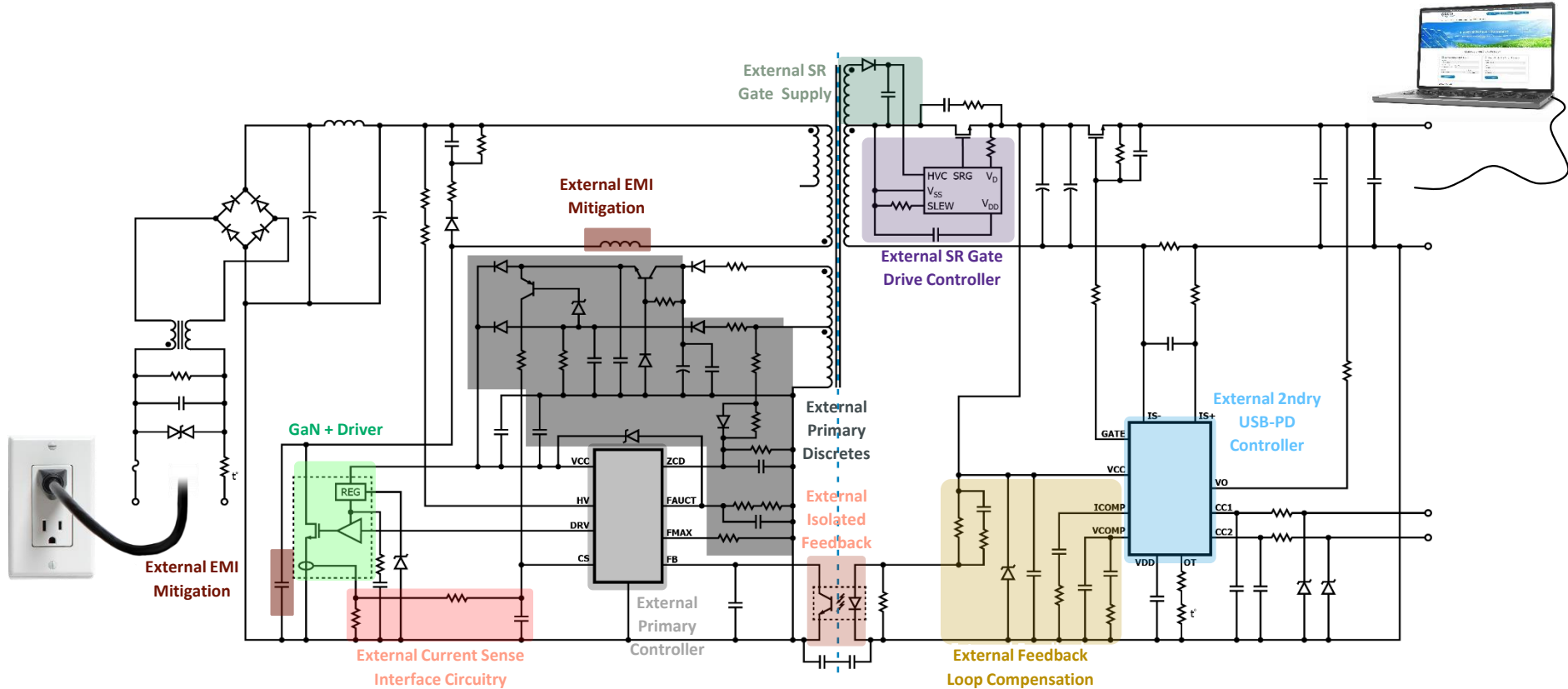

The Power of Integration - InnoSwitch

	Competition	InnoSwitch
GaN, Driver + Sense	Integrated	Integrated
GaN Sense Interface	External	Integrated
EMI Mitigation	External	Integrated
Primary Controller	External	Integrated
Primary Discrettes	External	Integrated
Isolated Feedback	External	Integrated
SR Gate Driver	External	Integrated
SR Gate Supply	External	Integrated
Feedback Loop Comp	External	Integrated
USB-PD Controller	External	Integrated
Component Count	101	45

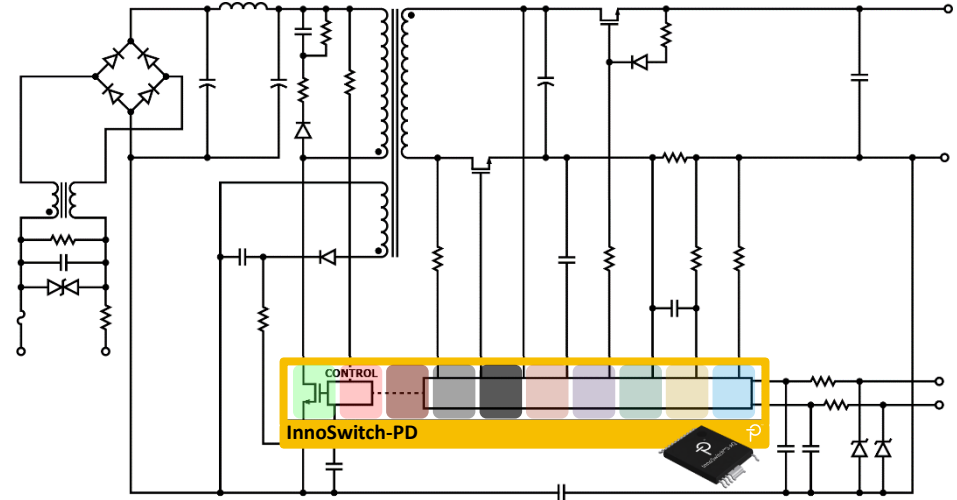

Bringing Efficiency & Integration Benefits to Gate Drivers

Leveraging Our HV Expertise and IP Portfolio in Gate Drivers

- Improves efficiency and reduces component count by 50%

Competitor

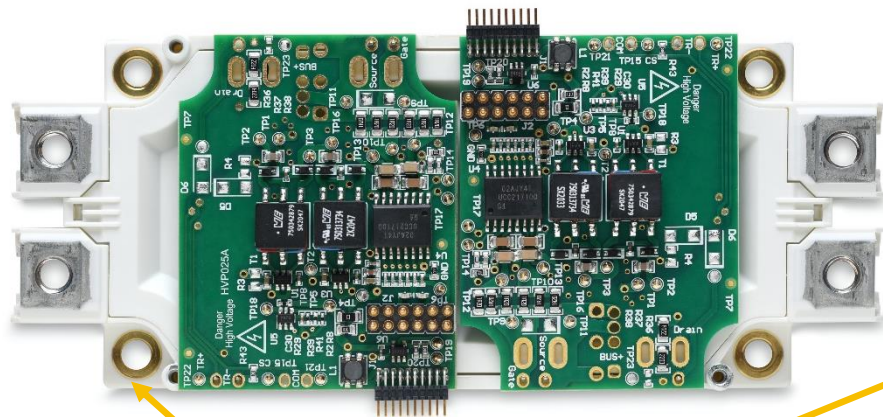

IGBT or SiC power module

SCALE-EV

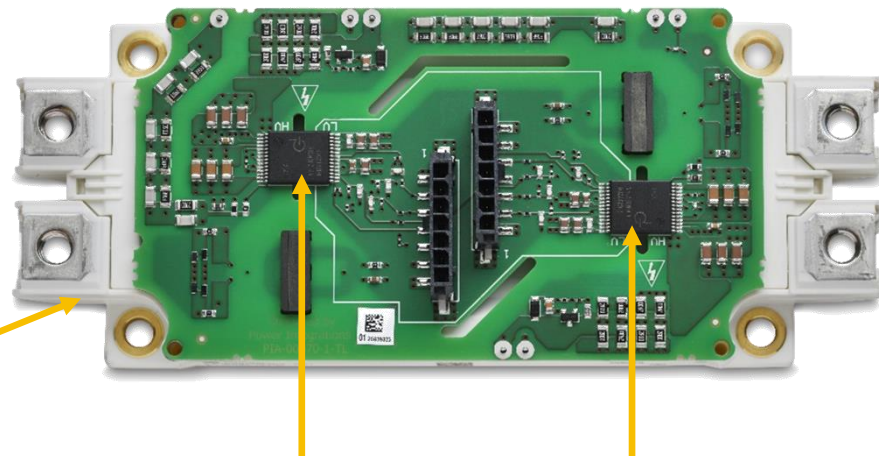

Same package as InnoSwitch including FluxLink for high-speed isolated communication

Products Serve Broad Range of End Applications

Power Integrations Model



Focused R&D
Handful of Products



Addressing Power Converters

Moderate R&D intensity, high differentiation, premium margins

1,000s
of Applications

Typical Analog Model



100s of ASSPs

1,000s
of Applications

Annuity Revenue Streams from Long-lived Products

52% of 2024 Sales from product families introduced 2001 and prior

Revenue by Product Family 1997-2024

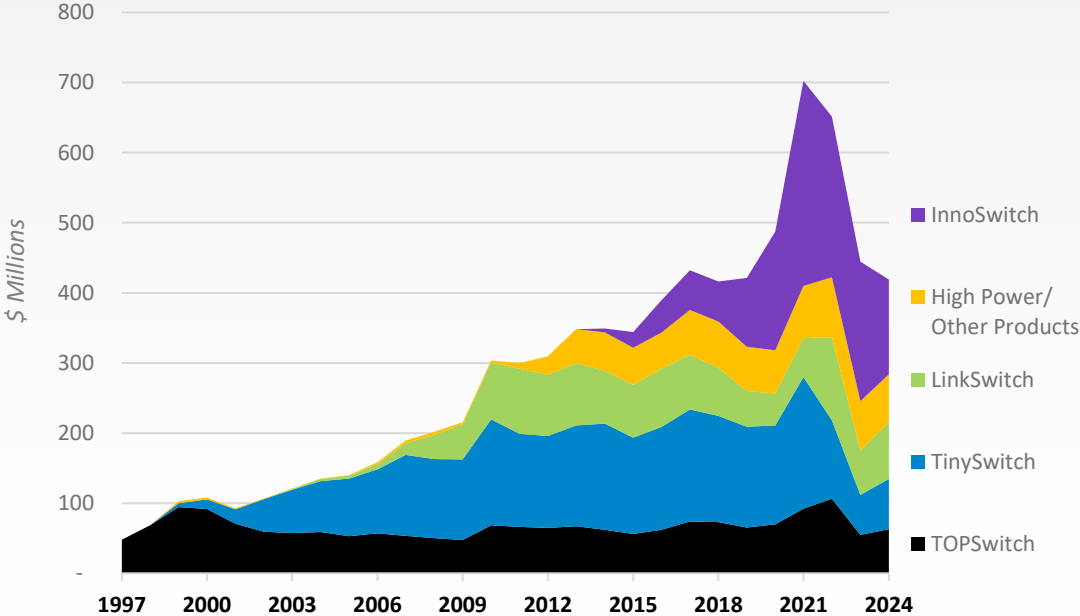

Unique Manufacturing Model: “Fabless IDM”

Best-in-class Assurance of Supply, Quality, and Cost

PI Develops, Owns, and Controls the Process Technologies, Device and IC Designs

- Own specific equipment as needed
- Replicate each process technology to multiple (2-5) partner fabs

Geographically Dispersed, Both Inter- and Intra-continental

Long-term Strategic Supply Alliances with IDMs



Key Takeaways

High voltage (HV) is a Unique Specialty,
and PI is the Only HV Pure Play

**Our Addressable Market is Expanding
and Diversifying**

GaN is the Future of HV Power Conversion,
and PI is the Leader in GaN

High-voltage Semiconductors are Crucial
to a Lower-carbon Future

Addressable Market of \$4B

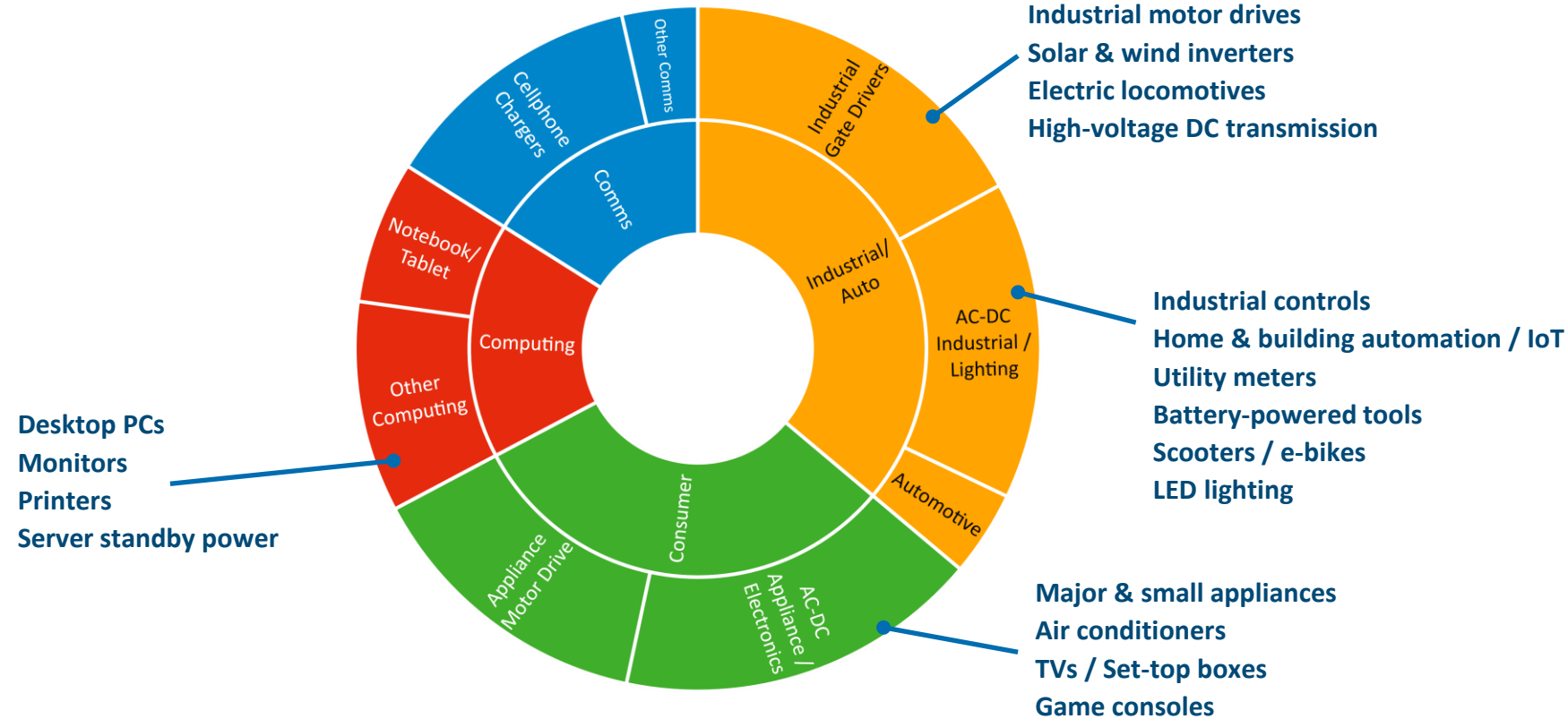

**Our SAM Will Double
from 2022 to 2027 &
Continue to Diversify**

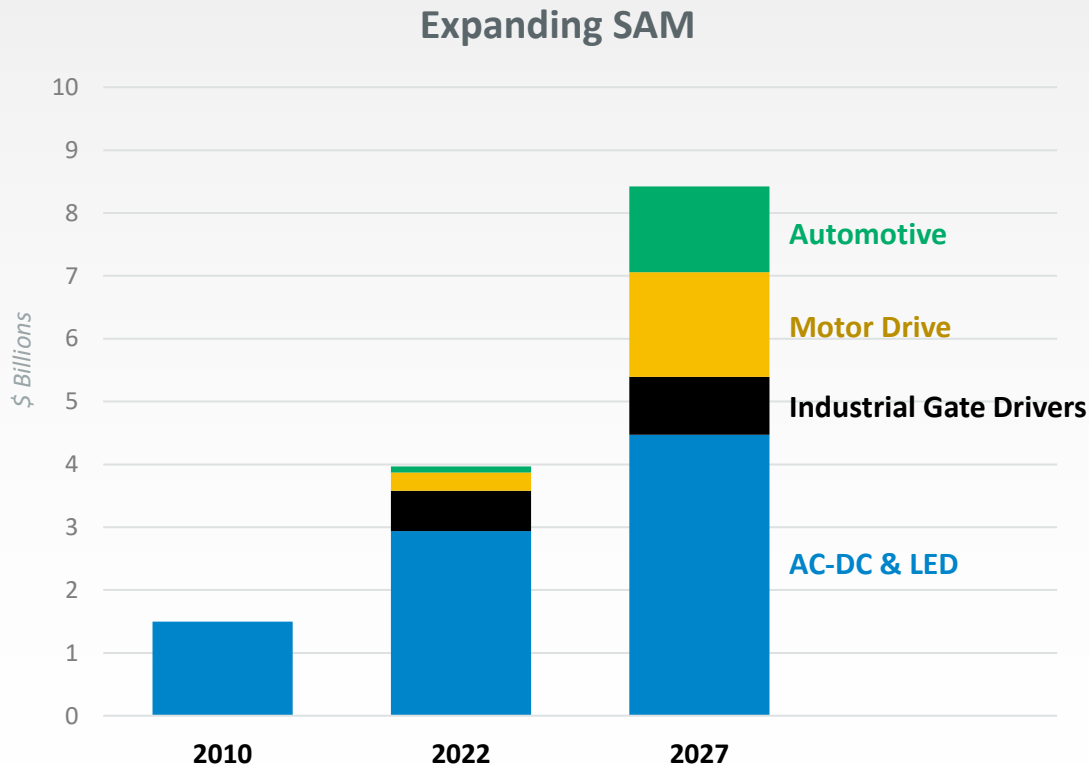

SAM to Double from 2022 to 2027

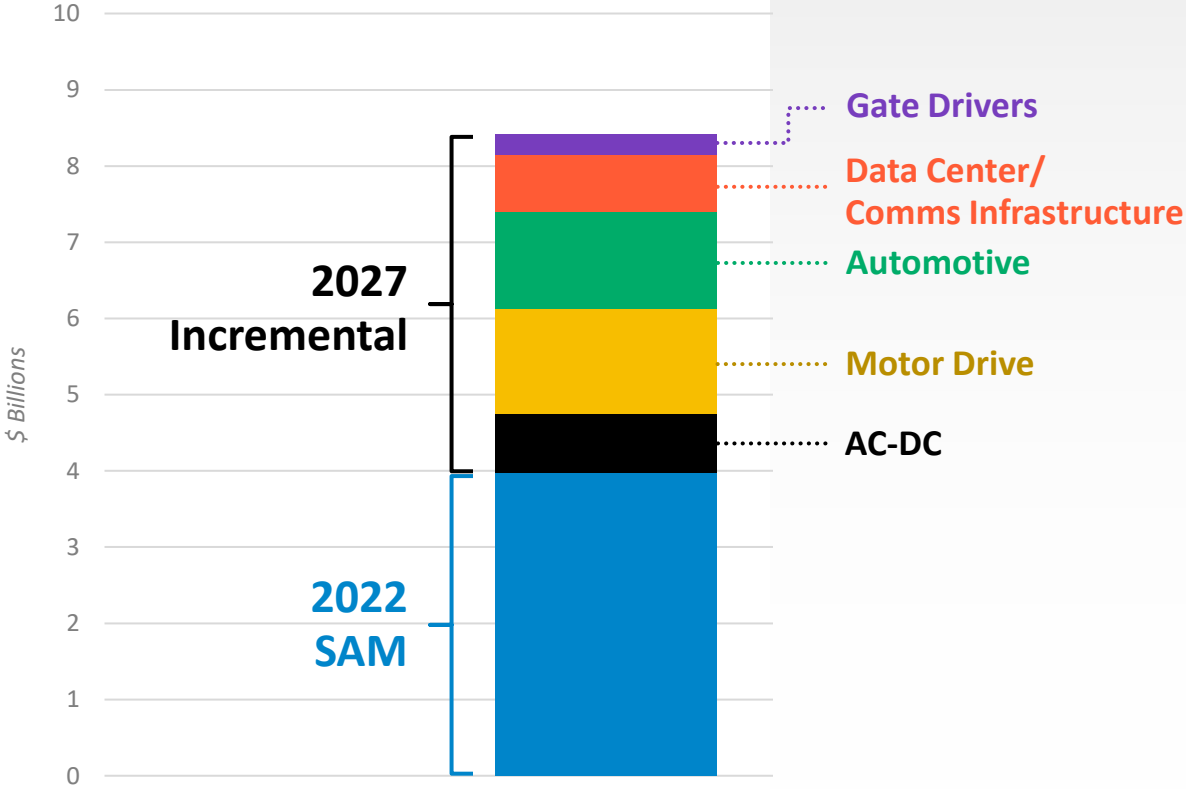

Big-Picture, Secular Trends

Driving Need for Advanced High-voltage Semiconductors

Smarter, More Efficient Appliances

- Connectivity, LED Lighting
- Transition to BLDC Motors



Advanced Chargers

- Higher power, higher efficiency
- Multiple ports
- Integrating USB PD interface



Electric Vehicles

- Brings high voltage to auto market
- Power supplies, charging, main inverter, etc.



Home and Building Automation / IoT

- USB wall ports, building access, smoke alarms, etc.
- Needs low standby power



Electrification/Electronification

- E-bikes, lawn equipment, tools
- LED lighting
- Electronic meters



De-carbonization

- Energy efficiency
- Renewable energy
- HVDC



Investing and Innovating to Expand SAM

Hiper Product Line

- Extended AC-DC power range from 50 to 500 watts



InnoSwitch Increases Dollar Content

- Integrates isolation and secondary-side functionality



Entered Gate Driver Market with Concept Acquisition

- Renewables
- Traction
- DC transmission



GaN Expands Dollar Content, Unlocks New End Markets

- Higher ASPs
- Extends reach to higher power levels



BridgeSwitch for BLDC Motors

- Expands content in appliances



New Innovations Serving Expanding Markets

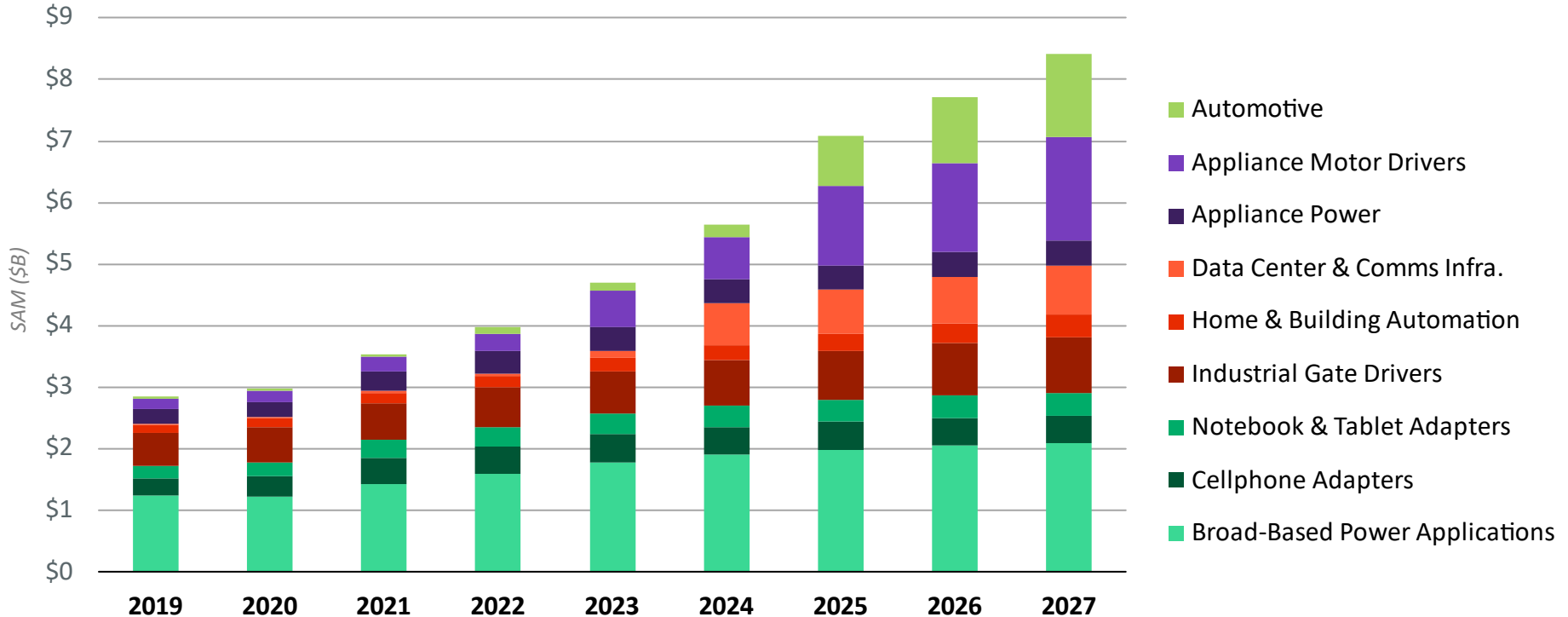

BridgeSwitch™ Motor-Driver ICs for BLDC Motors

Pumps, Fans, Compressors

- Residential & commercial appliances
 - Industrial applications
-

Washer/Dryer Drum Motors

Window Shades/Shutters & Garage Openers

Wide Range of High-Voltage Single or Multi-Phase PM or ACIM Motors



Robust High-Voltage Semiconductor Content in EVs

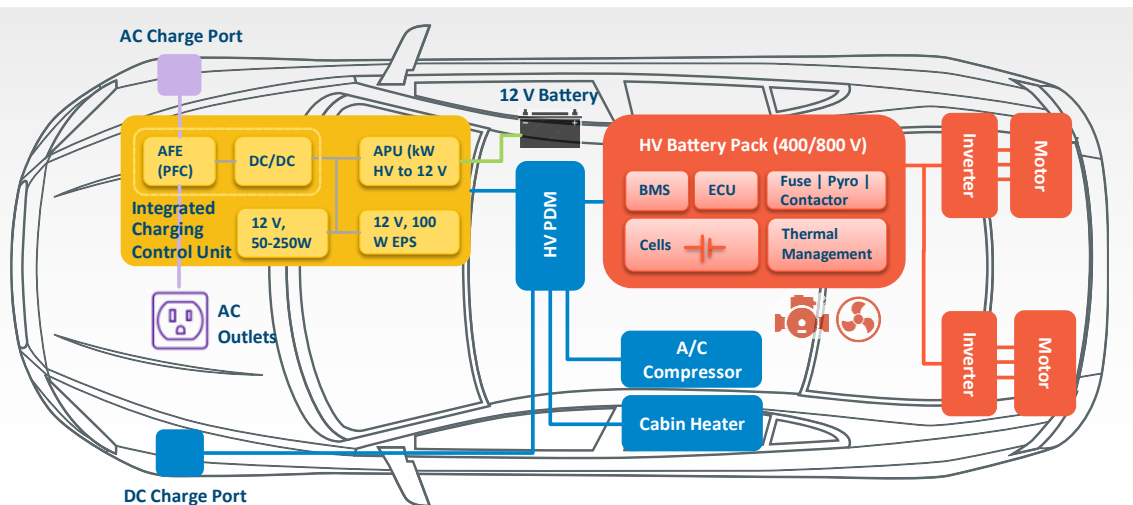

Integration crucial to reliability in automotive applications

InnoSwitch with GaN or SiC to suit battery voltage

Tens of dollars of content available with current products

Products in pipeline to expand content to >\$100

Up to 20 power supplies per car addressable with current products

- Auxiliary Power Supplies
- Inverter Emergency Power Supplies
- μ DC-DC Converters

GaN products in pipeline to address onboard charging, high-power DC-DC converters

Key Takeaways

High voltage (HV) is a Unique Specialty,
and PI is the Only HV Pure Play

Our Addressable Market is Expanding
and Diversifying

**GaN is the Future of HV Power Conversion,
and PI is the Leader in GaN**

High-voltage Semiconductors are Crucial
to a Lower-carbon Future

GaN is the Future of HV Power Conversion, and PI is the Leader in GaN

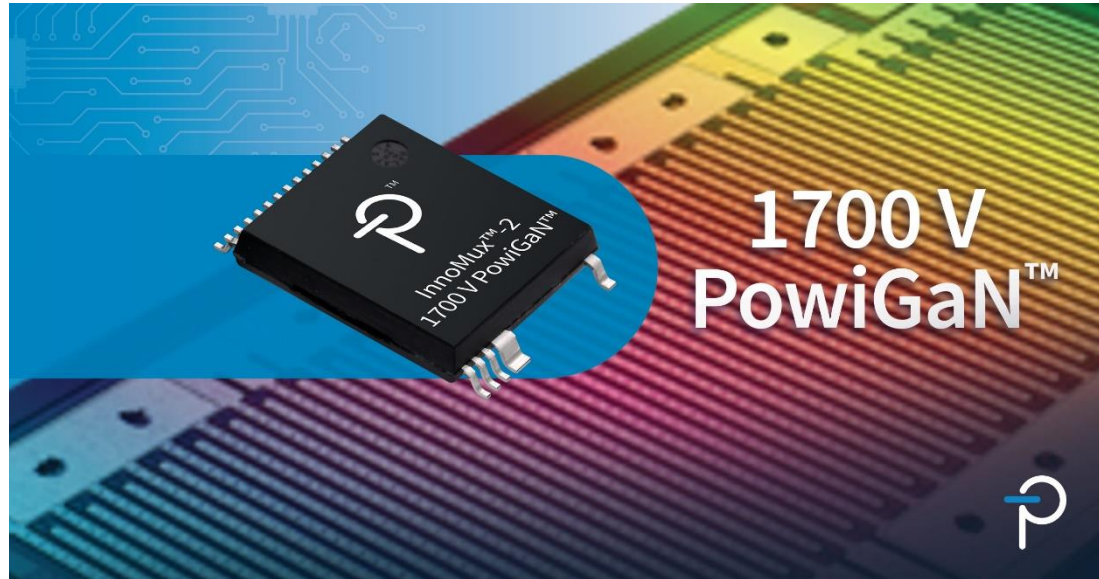

Proprietary GaN technology

We control the roadmap

Purpose-built for our products

We can tailor the GaN for each product

Highly cost-effective

Approaching parity with silicon

Higher-voltage capability

900 V and 1250 V products introduced in 2023,
1700 V in 2024

Compact 60W Charger with InnoSwitch4-CZ & ClampZero

Uses GaN-based MinE-CAP IC to reduce size of bulk capacitors

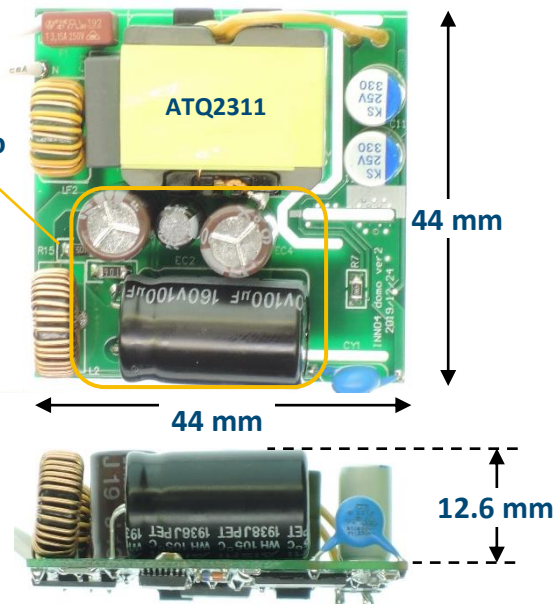

MinE-CAP

InnoSwitch4-CZ with GaN switch

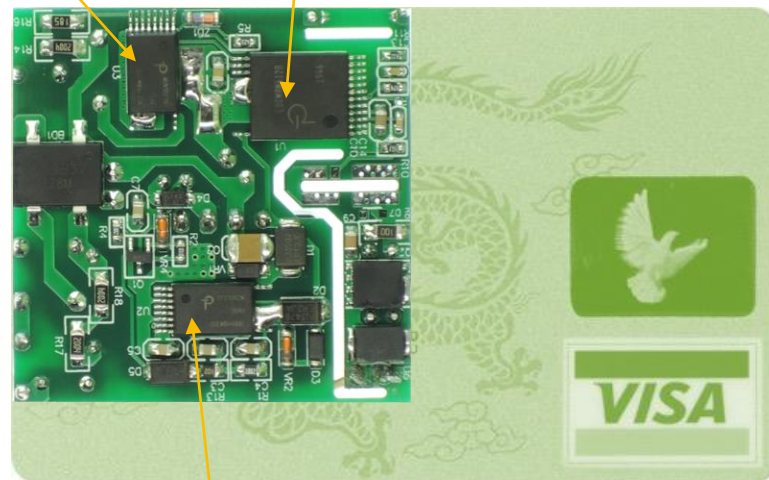

To Scale

Volume = 24.4 cm³
Power Density = 2.5 W/cm³
No heatsinks

GaN Creates Opportunities in Data Center, Comms Equipment

12M servers per year

Approx. **2.5 power supplies** per server

Standby power

- Existing business, high share
-

Main power

- AI drives up power needs, expanding opportunity for GaN-based ICs in development



Key Takeaways

High voltage (HV) is a Unique Specialty,
and PI is the Only HV Pure Play

Our Addressable Market is Expanding
and Diversifying

GaN is the Future of HV Power Conversion,
and PI is the Leader in GaN

**High-voltage Semiconductors are Crucial
to a Lower-carbon Future**

High-Voltage Semiconductors are Critical to a Lower-Carbon Future

Efficiency and renewables hold the key to achieving carbon-reduction targets

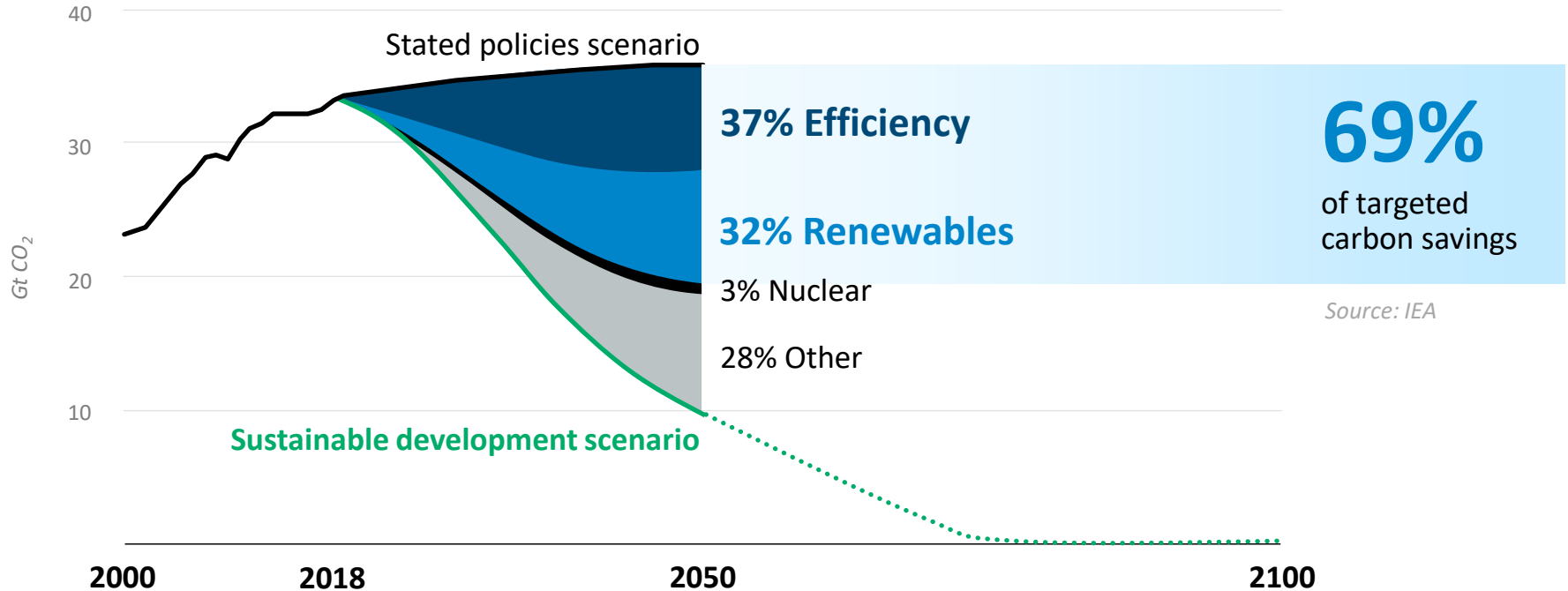

High-Voltage Semiconductors are Critical to a Lower-Carbon Future



**Renewable Energy
Generation**

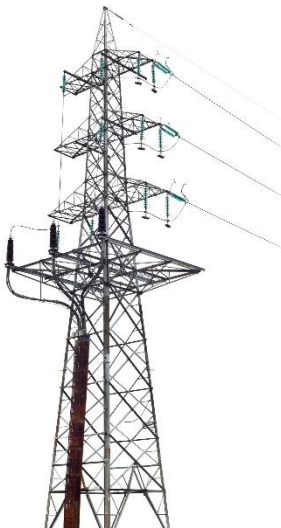

**Efficient Energy
Transmission**



**Efficient Energy
Consumption**



Recognized Leader in Energy Efficiency

Pioneer in Eliminating Standby Waste

Hundreds of Efficiency-related Patents

First to Market with GaN Power ICs

Inclusion in Numerous Sustainability Indices



Awards and Certifications



2024 Revenues
95% EU Taxonomy-Eligible*

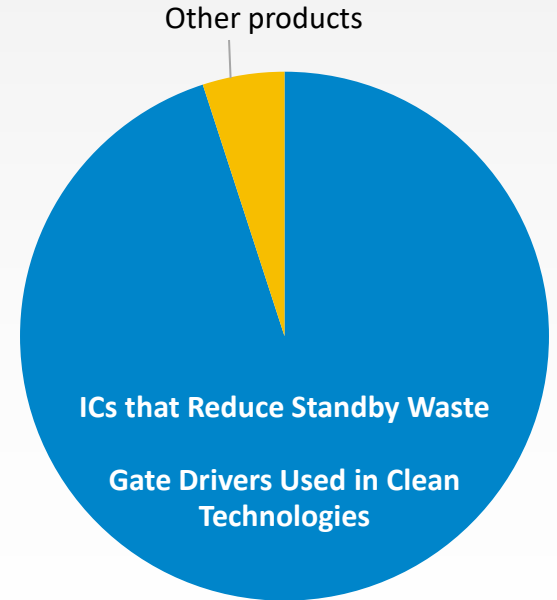

*Estimate based on information currently known to Power Integrations about taxonomy eligibility.



EcoSmart Technology Slashes Standby Waste

22 Billion

EcoSmart chips sold since 1998

Estimated 11.5 TWh of standby energy saved in 2024

- Equivalent to annual electricity usage of about 1.6M homes*
- Saved >8M tons of CO₂ emissions*

* Source: U.S. EPA Greenhouse Gas Equivalencies Calculator

Estimated Energy Savings from EcoSmart Devices

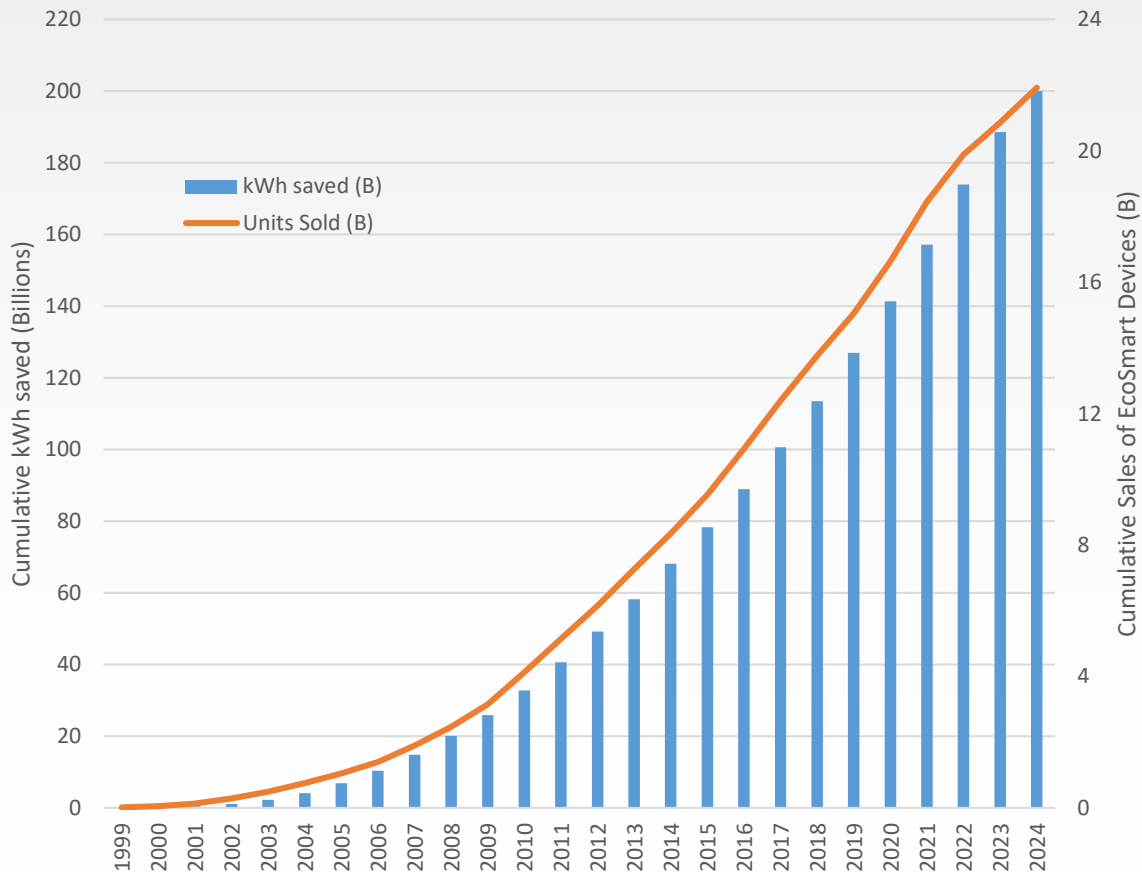

Energy Vampire vs. LinkZero™



System Solution with PowiGaN Delivers Superior Efficiency

**PowiGaN with
proprietary control
delivers highest efficiency
in standby & full load**

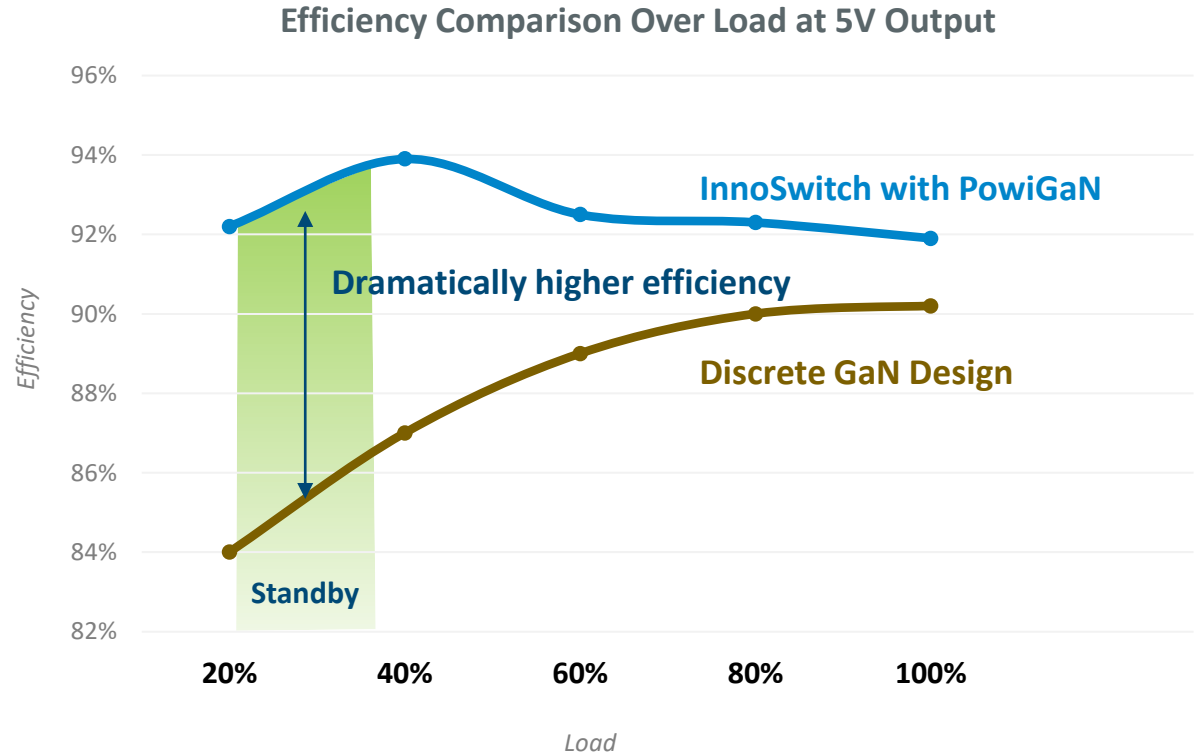

Enabler of Clean-Energy Technologies



LED
DRIVERS



Commercial/Industrial &
Smart LED Lighting



GATE
DRIVERS



Renewable Energy, Electric
Locomotives, High-voltage
DC Transmission



MOTOR
DRIVERS



Brushless DC Motors for
Appliances & Industrial



AUTOMOTIVE
SOLUTIONS



Reliable, Efficient Power
Supplies & Gate Drivers for EVs

Reducing Materials, Energy Use Through Integration

Up to 100 Components...



Are Replaced with Two Hiper ICs

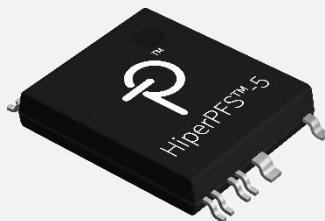

HiperPFS-5



HiperLCS-2

Technology Leadership Makes PI a Policy Influencer

Regular Consultation with Energy Policy Makers and Leading Researchers



Active Participation on Technical Committees for International Standards

- IEC TC47/SC47E for semiconductor devices
- JEDEC JC-70 wide bandgap semiconductors committee
- USB Implementers Forum



Power Sources Manufacturers Association (PSMA)

- Chairing energy management committee last 3+ years



Manufacturing Partners

Fab	Certifications	Carbon Reduction Plans
Partner 1	ISO 14001:2015 EMS Sony Green	<ul style="list-style-type: none">• Reduce GHG emissions 70% by FY2030 vs. 2019 level• Parent has goal of carbon neutrality throughout corporate value chain by 2050
Partner 2	ISO 14001:2015 EMS ISO 45001:2018 Occupational Health & Safety Sony Green	<ul style="list-style-type: none">• Targeting CO2 30% reduction by 2030 in two facilities• Third facility targeting "zero environmental footprint" by 2050; 2025 goals include increasing use of renewable energy to >15% and 5% reduction in energy per unit
Partner 3	ISO 14001:2015 EMS Sony Green	<ul style="list-style-type: none">• By 2030, reduce GHG emissions in line with 1.5°C• Carbon negative & underground resource free by 2050
Partner 4	ISO 14001:2015 EMS Sony Green	<ul style="list-style-type: none">• Reported ~25t CO2 reduction in 2020

All assembly & test partners certified Sony Green, ISO14001 (EMS) and ISO 45001:2018 (Occupational Health & Safety).

Lowering Our Internal Carbon Footprint

Extensive Use of Solar Energy in Our Operations



**600 kW System at
San José HQ**
Major Expansion in 2024



**25 kW at
Switzerland Facility**



**43 kW at
Germany Facility**

Our Contribution to a Lower-Carbon Future

Pioneer in Cutting Standby Power Waste

Driving Higher Efficiency with GaN

Enabling Clean Technologies

Saving Energy & Materials Through Integration

Recognized Efficiency Expert & Policy Influencer

Lowering Carbon Footprint of Our Operations

Financials



**Best Financially Managed Semiconductor Company Achieving up
to \$1 Billion in Annual Sales**

Consistent, Disciplined Approach to Management

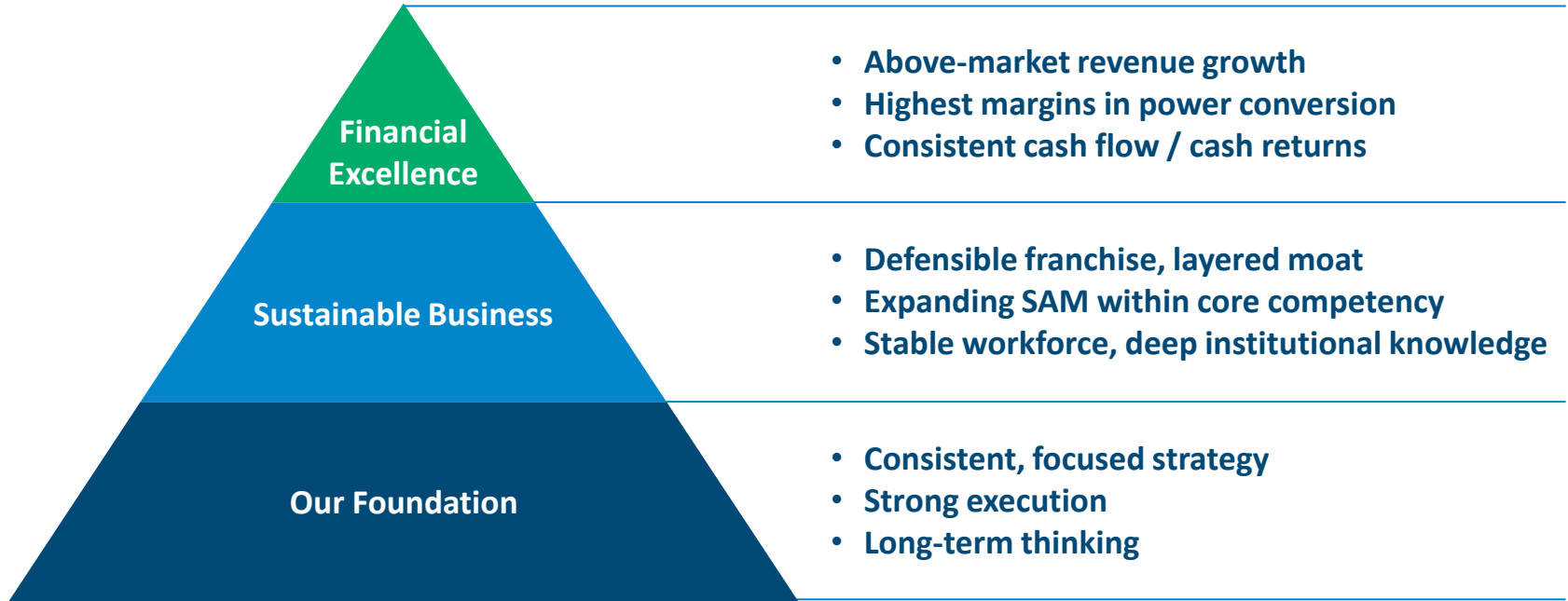

Focused Strategy and System-Level Innovation Drive Above-Market Growth

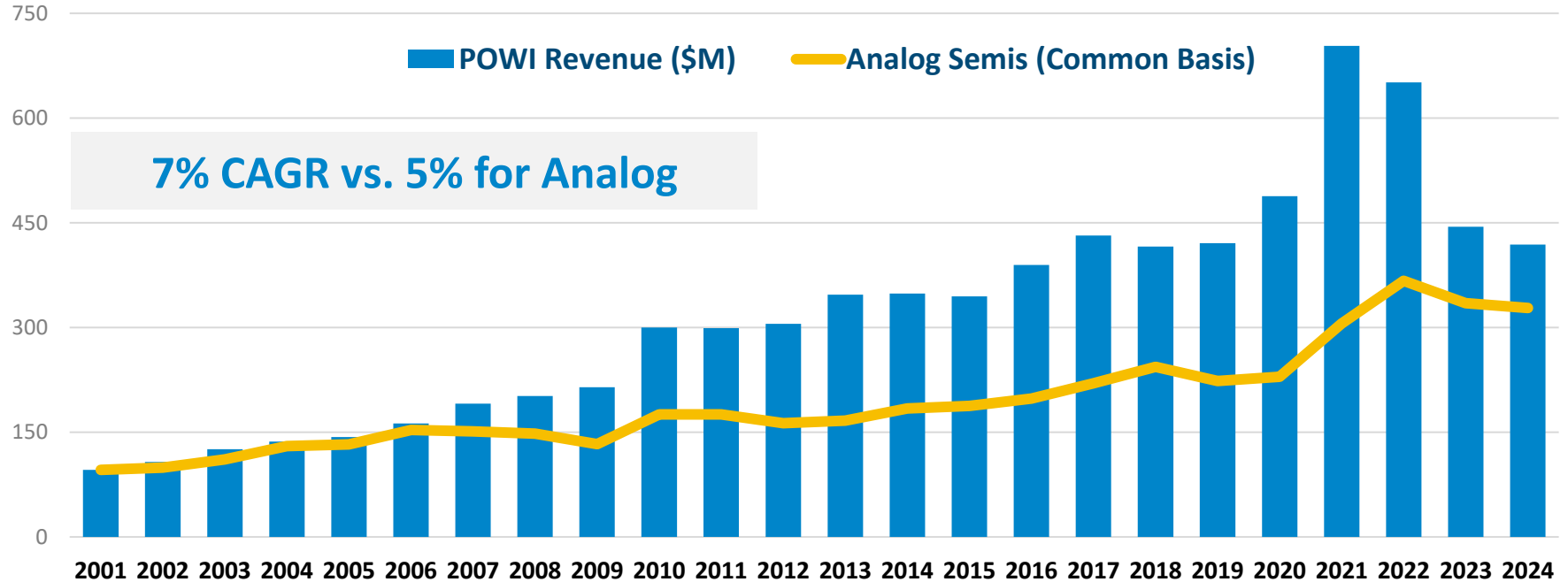

Note: Analog industry data is per World Semiconductor Trade Statistics; PI revenues prior to 2017 do not reflect ASC 606 recast.



Favorable Shift in Revenue Mix

Revenue Mix by End-Market Category

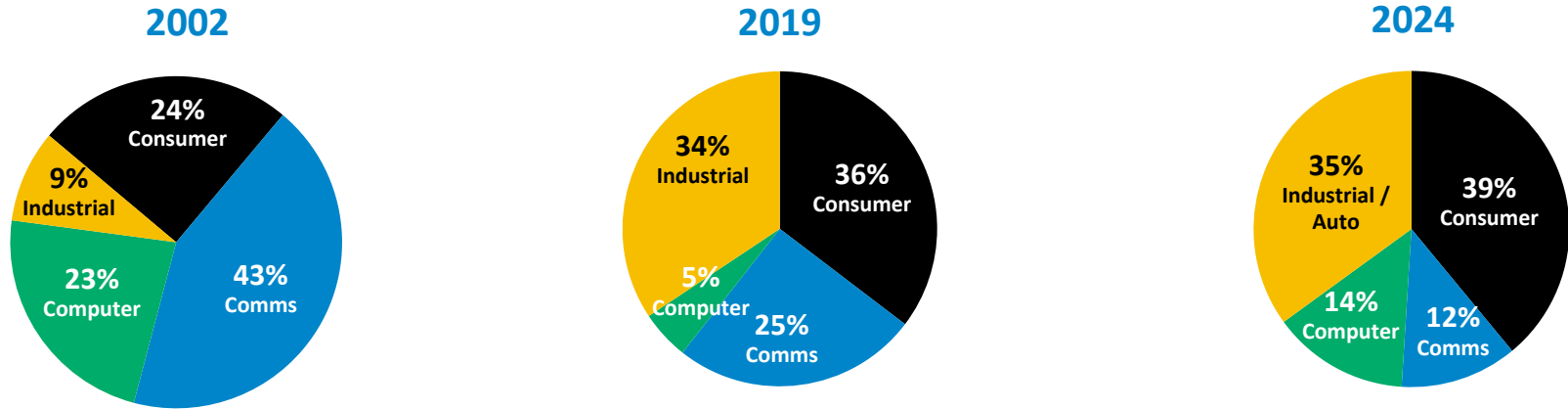

Industrial/Auto/Consumer >70% of mix

- Appliances accounted for ~90% of consumer category in 2024
- Smaller contribution from volatile, lower-margin cellphone chargers (in comms)

Target Financial Model

Revenue Growth

GaN products, renewables, HVDC, metering, automotive, motor-drive products

SAM to \$8B by 2027

Rising Dollar Content

Driven by integration, higher power, GaN

3-5 Year Target Model

Revenue Growth	Low-double-digit CAGR
Non-GAAP Gross Margin	50-55%
Non-GAAP Operating Margin	25-30%
Capital Expenditures	5-7% of sales

Profitability/Cash Flow

Fabless IDM model
Premium GM, modest CAPEX

R&D Leverage
Focused product portfolio

Richer Mix
More industrial/auto/appliance

Gross Margin Stability Over Time and Cycles

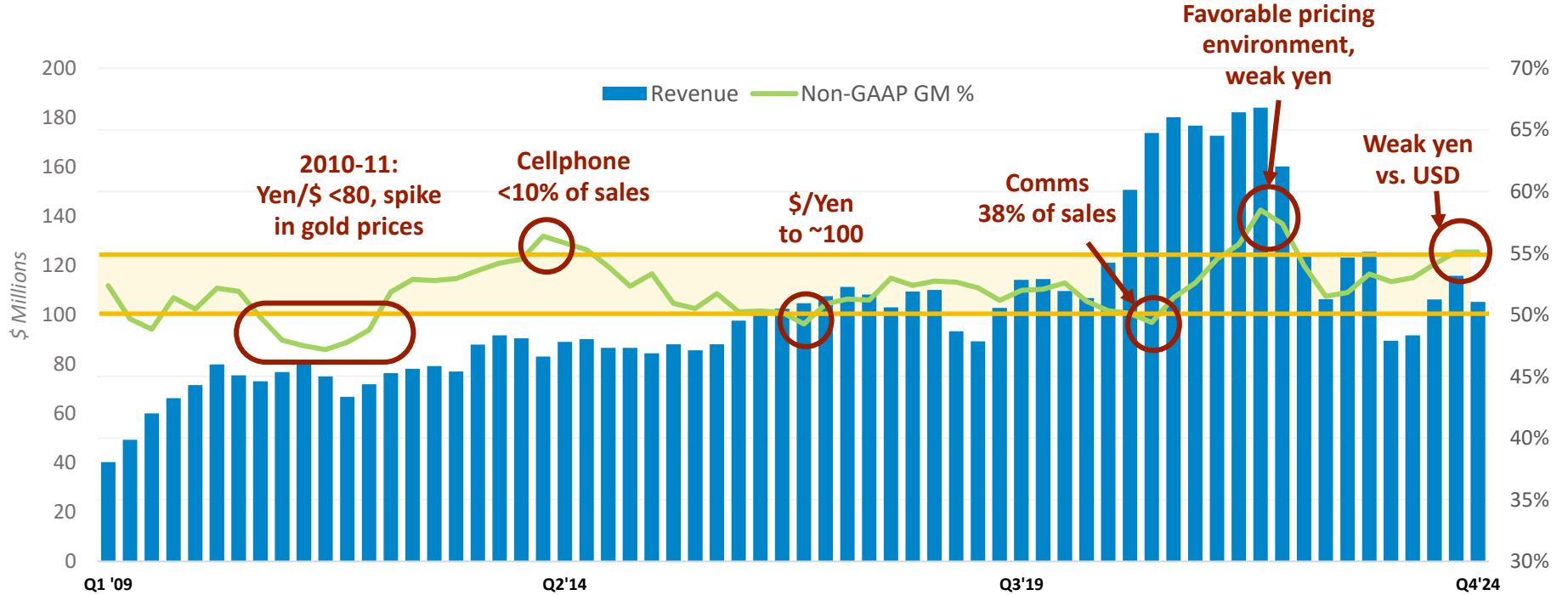

Strong Cash Flow, Healthy Returns to Stockholders

15%

FCF*/Revenue in 2024

185%

of FCF returned to
stockholders 2022-24

\$29

Average price on
buybacks since 2008

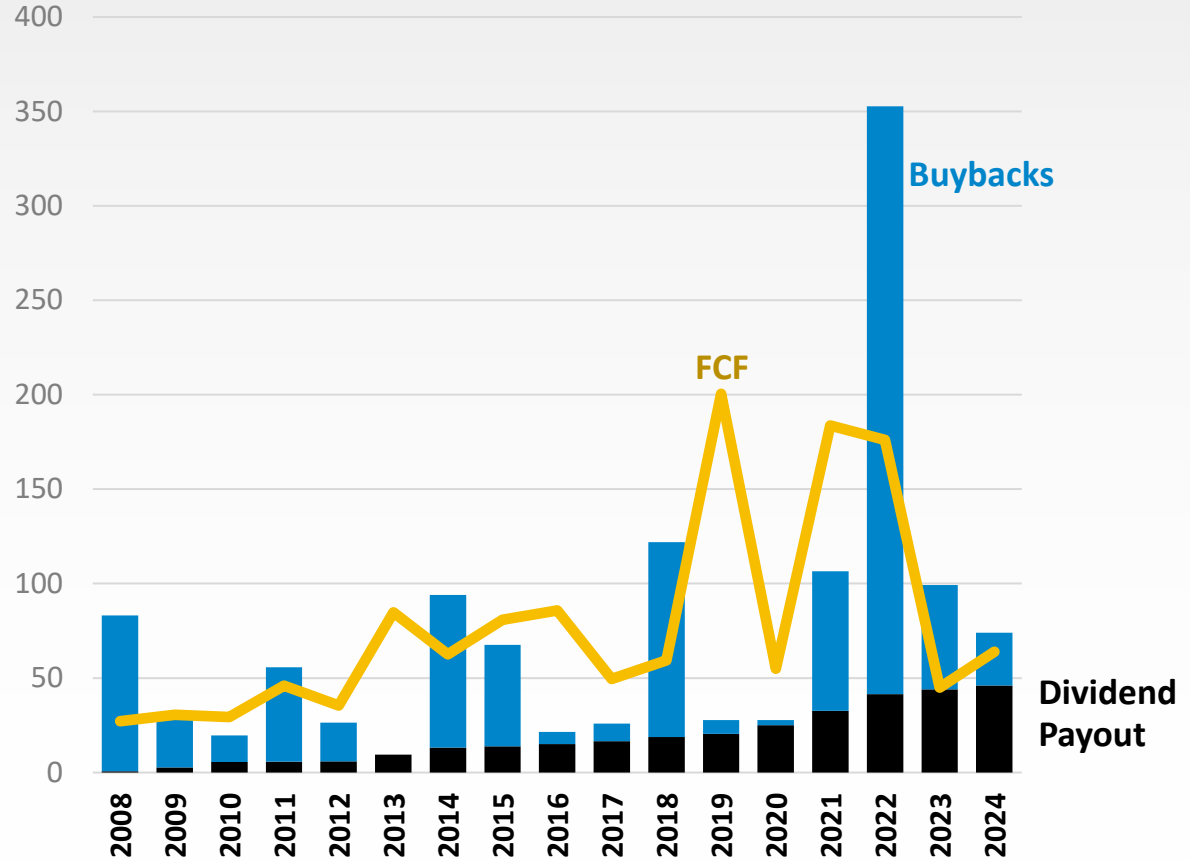

*2024 Free cash flow = \$81.2M cash flow from operations less \$17.3M capex



Strong Balance Sheet

at December 31, 2024

- **\$300M cash and investments**
- **No debt**
- **Dividend payer since 2008**
 - ▶ Quarterly dividend of \$0.21
 - ▶ Dividend increased by 5% in Q4 2024
- **Share count down 13% since 2008**
 - ▶ \$50M repurchase authorization announced in November 2024

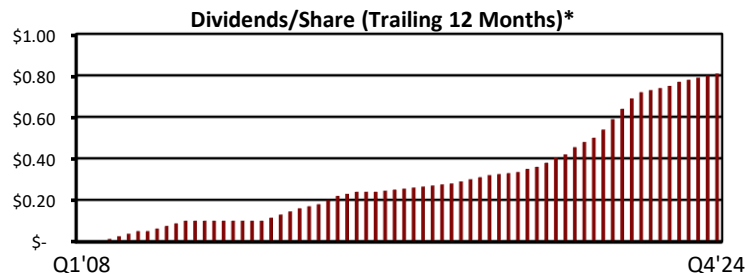
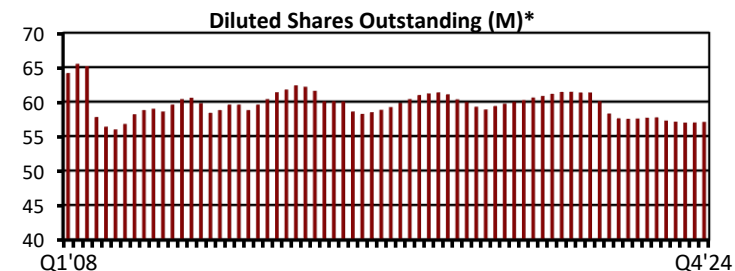
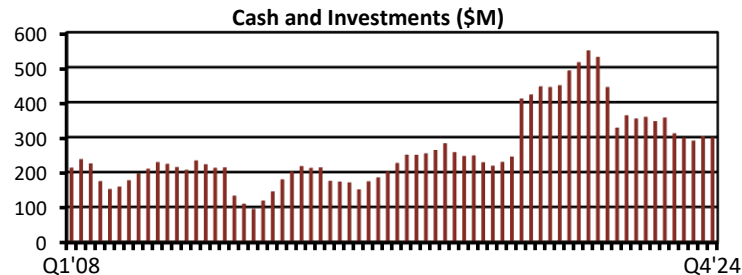

*Adjusted for August 2020 2:1 stock split

Summary

Focused Strategy – The Only HV Pure Play

Committed to Disruptive Innovation

Defensible, System-level Integration

Capitalizing on Big-Picture, Secular Trends

Track Record of Growth & Profitability

Making a Difference to the Environment

power
integrations™